



# GENUINE PARTS

## INSTALLATION INSTRUCTIONS

**1. DESCRIPTION:** Tonneau Cover Kit

**2. APPLICATION:** QX70

**3. PART NUMBERS:** H4982-1CA0A (BEIGE)  
H4982-1CA0B (BLACK)

### 4. KIT CONTENTS:

Item	QTY	Description	Part Number
A	1	Tonneau cover	-
B	1	Tonneau cover RR	-
C	1	Installation Instructions replacement template	-

A



B



C

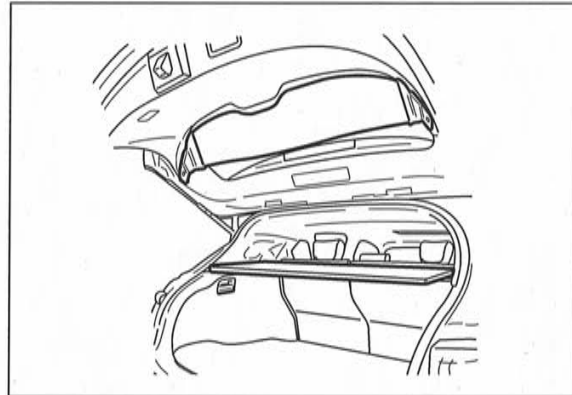
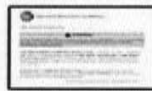

### 5. TOOLS REQUIRED:

Plastic pry bar

### 6. PRE-INSTALLATION CAUTIONS/NOTES:

1. Before starting the operations, read the following cautions so that the correct installation can be performed safely and securely.
2. We may not assume responsibility for malfunctions that are caused by your failure to observe the cautions and notes.

#### CAUTION

1. When installing this product, be careful not to apply an excessive force to the product.
2. Before installing this product, the clips on the vehicle side will be detached.  
These clips will be used again. Be sure to keep them so that they may not be lost.
3. When installing this product, be careful not to scratch the vehicle, etc.

## Tonneau Cover Kit

### 7. PREPARATION OF INSTALLATION:

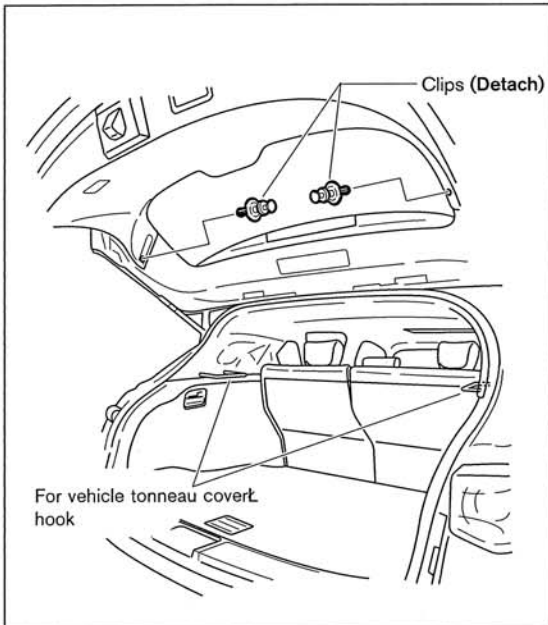

#### 1) Removal and confirmation of vehicle parts

- Open the back door.
- Remove the vehicle clips (two, right and left) of the back door trim, using a plastic pry bar.

#### **NOTE:**

The two vehicle clips that have been removed will be used again.

### 8. INSTALLATION PROCEDURE:

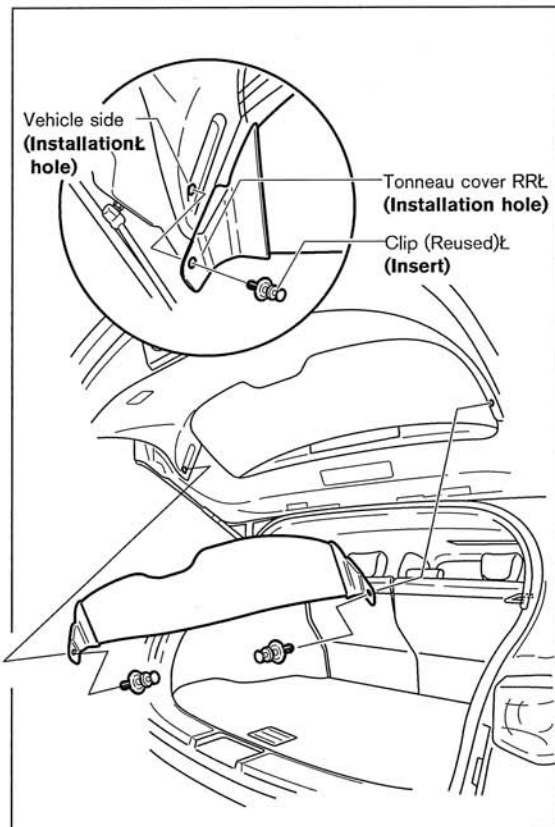

#### 1) Installation of tonneau cover RR

- Align the hole positions by sliding the cover onto the recessed sections of the back door trim on the right and left sides.
- Insert the vehicle clips that have been removed and secure the cover.

# Tonneau Cover Kit

## 2) Installation of tonneau cover

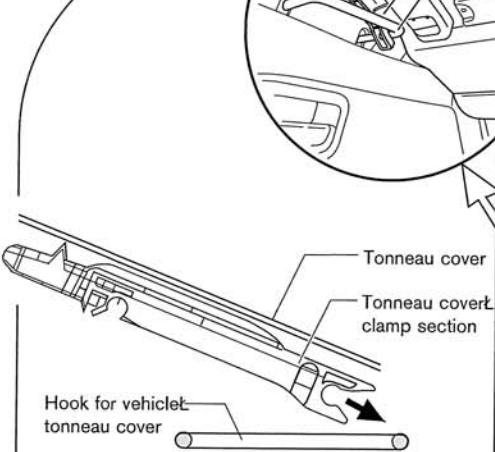
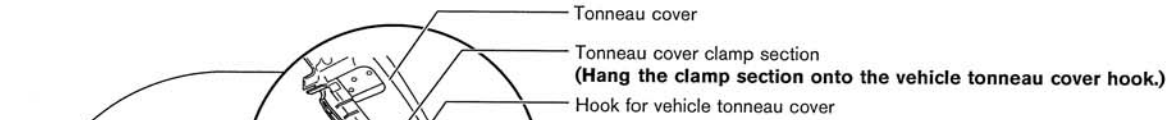

Insert the front part of the clamp of the tonneau cover to the hook for vehicle tonneau cover.

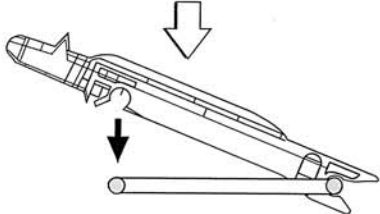

Push down the rear part of the clamp until you hear a click sound.

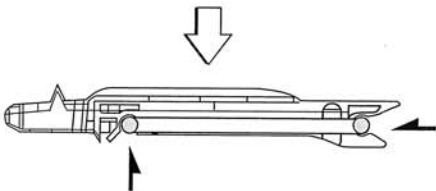

Ensure that the tonneau cover has been fully inserted into the hook for vehicle tonneau cover.

● Push down the rear seat back to the front.

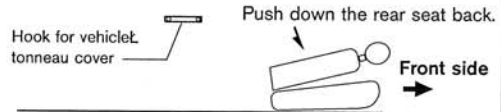

● Fold the tonneau cover.

● Pass the lower part of the hook for vehicle tonneau cover to the front side.

● Lift the rear edge of the tonneau cover. Pass the upper part of the hook for vehicle tonneau cover and pull it to the rear.

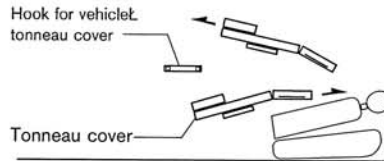

● Install the tonneau cover clamp section, following the detailed procedure shown on the left side.

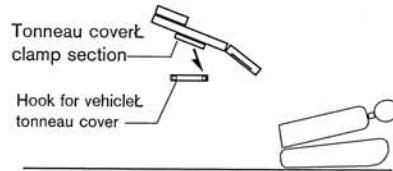

● Set the tonneau cover.

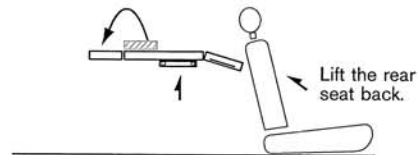

### NOTE:

When inserting front part of the clamp section onto the hook for vehicle tonneau cover, carry out this operation at the same time for both right and left sides.

## Tonneau Cover Kit

### 9. HANDLING PROCEDURE:

The rear end of the tonneau cover opens upward.

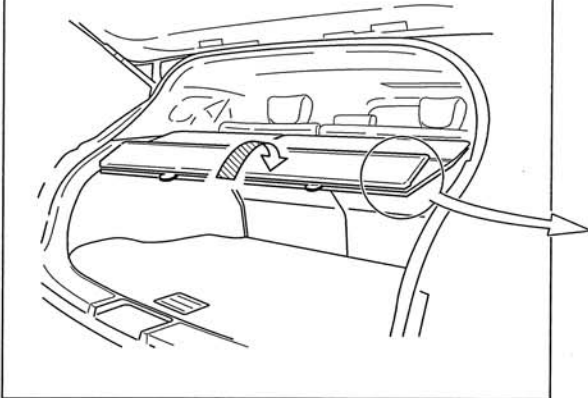

### 1) How to use tonneau cover

- a) The rear end of the tonneau cover opens upward. This allows easy loading and unloading of the luggage.

#### Details

The rear end of the tonneau cover opens upward.

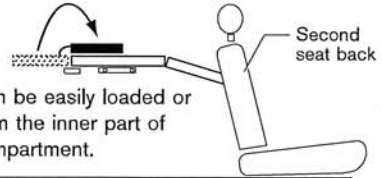

The luggage can be easily loaded or unloaded to/from the inner part of the luggage compartment.

### 10. HANDLING INSTRUCTIONS:

#### CAUTION

1. Ensure that the tonneau cover and tonneau cover RR are installed securely.
2. When loading a luggage to the luggage compartment, check the height of the luggage.
3. Do not put anything on the tonneau cover.
4. Although the tonneau cover moves according to the reclining of the rear seat, please perform the reclining operation slowly.